49" Wide Screen Digital LED Television

FLD4900



Instruction Manual

Read all of the instructions before using this TV and keep the manual in a safe place for future reference.

Contents

1. INTRODUCTION.....	3
1.1. Safety Information.....	3
1.2. TV Base Stand assembly.....	7
1.3. General View.....	8
1.3.1. Front and Back.....	8
1.3.2. Connection Panel	9
1.3.3. Remote Control.....	10
2. INSTALLATION.....	12
2.1. Power Supply Connection.....	12
2.2. RF Antenna Connection.....	12
2.3. Connecting via Composite Video.....	13
2.4. Connecting via Component Video.....	13
2.5. Connect to Digital Audio Amplifier.....	14
2.6 Connecting via HDMI.....	14
3. SETUP WIZARD.....	15
3.1. Select Language.....	15
3.2. Select Time.....	15
3.3. Auto Scan.....	16
4. SELECT INPUT SOURCE.....	17
4.1. Main Menu.....	17
5. MAIN MENU OPERATION.....	18
5.1. Picture Menu.....	18
5.2. Sound Menu.....	21
5.3. Time Menu.....	23
5.4. Setup Menu.....	24
5.5. Close Caption.....	25
5.6. Lock Menu.....	30
5.7. US Rating.....	32
5.7.1. TV.....	32
5.7.2. MPAA.....	33
5.7.3. Canada Rating.....	33
5.8. Channel Menu.....	34
6. MEDIA.....	36
6.1. Media OPERATION.....	36
6.2. Photo Menu.....	37
6.3. Music Menu.....	38
7. TROUBLE SHOOTING.....	39
8. SPECIFICATIONS.....	41

Introduction

1.1 Safety Instructions

To ensure reliable and safe operation of this equipment, please read carefully all the instructions in this user guide, especially the safety information below.



CAUTION: TO REDUCE THE RISK OF ELECTRIC SHOCK, DO NOT REMOVE COVER (OR BACK). NO USER-SERVICEABLE PARTS INSIDE. REFER SERVICING TO QUALIFIED SERVICE PERSONNEL.



The lightning flash with arrowhead symbol within an equilateral triangle is intended to alert the user to the presence of non-insulated “dangerous voltage” within the product’s enclosure that may be of sufficient magnitude to constitute a risk of electric shock.



The exclamation point within an equilateral triangle is intended to alert the user to the presence of important operating and maintenance instructions in the literature accompanying the appliance.

WARNING: TO REDUCE THE RISK OF FIRE OR ELECTRIC SHOCK, DO NOT EXPOSE THIS APPARATUS TO RAIN OR MOISTURE.

Introduction

CAUTION: Use of controls or adjustments or performance of procedures other than those specified herein may result in hazardous radiation exposure.

Please, carefully study this manual and always keep it available. There are, however, some installation and operation precautions which you should be aware of:

1. **READ INSTRUCTIONS:** All the safety and operating instructions should be read before this product is operated.
2. **RETAIN INSTRUCTIONS:** The safety and operating instructions should be retained for future reference.
3. **HEED WARNINGS:** All warnings on the appliance and in the operating instructions should be adhered to.
4. **FOLLOW INSTRUCTIONS:** All operating and use instructions should be followed.
5. **CLEANING:** Unplug this product from the wall outlet before cleaning. Do not use liquid cleaners or aerosol cleaners. Use a damp cloth for cleaning.
6. **ATTACHMENTS:** Do not use attachments not recommended by the product manufacturer as they may cause hazards.
7. **WATER AND MOISTURE:** Do not use this product near water—for example, near a bath tub, wash bowl, kitchen sink, or laundry tub—in a wet basement or near a swimming pool and the like.
8. **ACCESSORIES:** Do not place this product on an unstable cart, stand, tripod, bracket or table. The product may fall, causing serious injury to a child or adult and serious damage to the product. Use only with a cart, stand, tripod, bracket or table recommended by the manufacturer or sold with the product. Any mounting of the product should follow the manufacturer's instructions and use a mounting accessory recommended by the manufacturer. A product and cart combination should be moved with care: Quick stops, excessive force and uneven surfaces may cause the product and cart combination to overturn. 
9. **VENTILATION:** Slots and openings in the cabinet are provided for ventilation and to ensure reliable operation of the product and to protect it from overheating, and these openings must not be blocked or covered. The openings should never be blocked by placing the product on a bed, sofa, rug, or other similar surface. This product should not be placed in a built-in installation such as a bookcase or rack unless proper ventilation is provided or the manufacturer's instructions have been adhered to.
10. **POWER SOURCE:** This product should be operated only from the type of power source indicated on the marking label. If you are not sure of the type of power supply to your home, consult your product dealer or local power company.
11. **GROUNDING OR POLARIZATION:** This product may be equipped with a polarized alternating-current line plug (a plug having one blade wider than the other). This plug will fit into the power outlet only one way. This is a safety feature. If you are unable to insert the plug fully into the outlet, try reversing the plug. If the plug should still fail to fit, contact your electrician to replace your obsolete outlet. Do not defeat the safety purpose of the polarized plug.
12. **POWER-CORD PROTECTION:** Power-supply cords should be routed so that they are not likely to be walked on or pinched by items placed upon or against them, paying particular attention to the plugs, convenience receptacles, and the point where they exit from the product.

Introduction

13. **OUTDOOR ANTENNA GROUNDING:** If an outside antenna or cable system is connected to the product, be sure the antenna or cable system is grounded so as to provide some protection against voltage surges and built-up static charges. Article 810 of the National Electrical Code, ANSI/NFPA 70, provides information with regard to proper grounding of the mast and supporting structure, grounding of the lead-in wire to an antenna-discharge unit, size of grounding conductors, location of antenna-discharge unit, connection to grounding electrodes, and requirements for the grounding electrode.

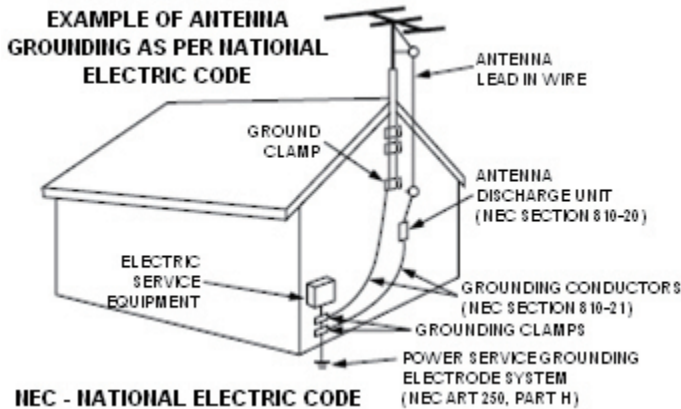

14. **LIGHTNING:** For added protection for this product during a lightning storm, or when it is left unattended and unused for long periods of time, unplug it from the wall outlet and disconnect the antenna or cable system. This will prevent damage to the product due to lightning and power-line surges.
15. **POWER LINES:** An outside antenna system should not be located in the vicinity of overhead power lines or other electric light or power circuits, or where it can fall into such power lines or circuits. When installing an outside antenna system, extreme care should be taken to keep from touching such power lines or circuits as contact with them might be fatal.
16. **OVERLOADING:** Do not overload wall outlets, extension cords or integral convenience receptacles as this can result in a risk of fire or electric shock.
17. **OBJECT AND LIQUID ENTRY:** Never push objects of any kind into this product through openings as they may touch dangerous voltage points or short-out parts that could result in a fire or electric shock. Never spill liquid of any kind on the product.
18. **SERVICING:** Do not attempt to service this product yourself as opening or removing covers may expose you to dangerous voltage or other hazards. Refer all servicing to qualified service personnel.
19. **DAMAGE REQUIRING SERVICE:** Unplug this product from the wall outlet and refer servicing to qualified service personnel under the following conditions:
- When the power-supply cord or plug is damaged
 - If liquid has been spilled, or objects have fallen into the product
 - If the product does not operate normally by following the operating instructions. Adjusting only improper adjustment of other controls may result in damage and will often require extensive work by a qualified technician to restore the product to its normal operation
 - If the product has been dropped or damaged in any way
 - When the product exhibits a distinct change in performance—this indicates a need for service

Introduction

- 20. **REPLACEMENT PARTS:** When replacement parts are required, be sure the service technician has used replacement parts specified by the manufacturer or have the same characteristics as the original part. Unauthorized substitutions may result in fire, electric shock or other hazards.
- 21. **SAFETY CHECK:** Upon completion of any service or repairs to this product, ask the service technician to perform safety checks to determine that the product is in proper operating condition.
- 22. **WALL OR CEILING MOUNTING:** The product should be mounted to a wall or ceiling only as recommended by the manufacturer.
- 23. **HEAT:** The product should be situated away from heat sources such as radiators, heat registers, stoves, or other products (including amplifiers) that produce heat.
- 24. **MAINS PLUG:** Is used as the disconnect device. It shall remain readily operable, and should not be obstructed during intended use.

Introduction

1.2 TV Base Stand Assembly

1. Align the TV unit and the stand. Hold the TV stand in place until TV locks and arrowhead points match.
2. Fix the screws into the TV stand after installing the TV and TV stand.

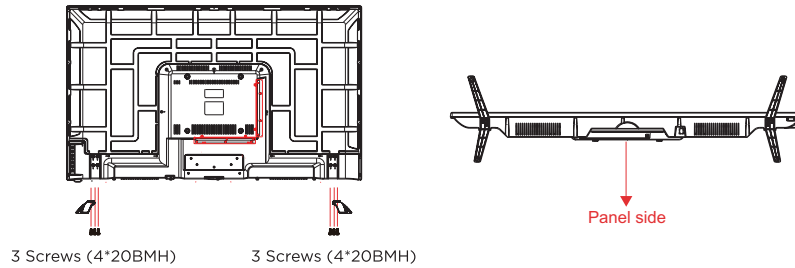

3. Mounting on the wall

This unit is VESA-compliant, and is designed to be wall-mounted with a VESA-compliant 15.75" x 7.87" (200mm x 200mm) mounting kit designed for flat-panel TVs (not included). Mount this unit according to the instructions included in the mounting kit. Length of screw should not exceed 12mm.

NOTE: Remove the base stand before mounting the unit on the wall.

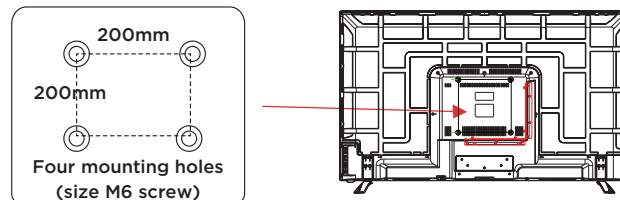

Introduction

1.3 General View

1.3.1 Front and Back

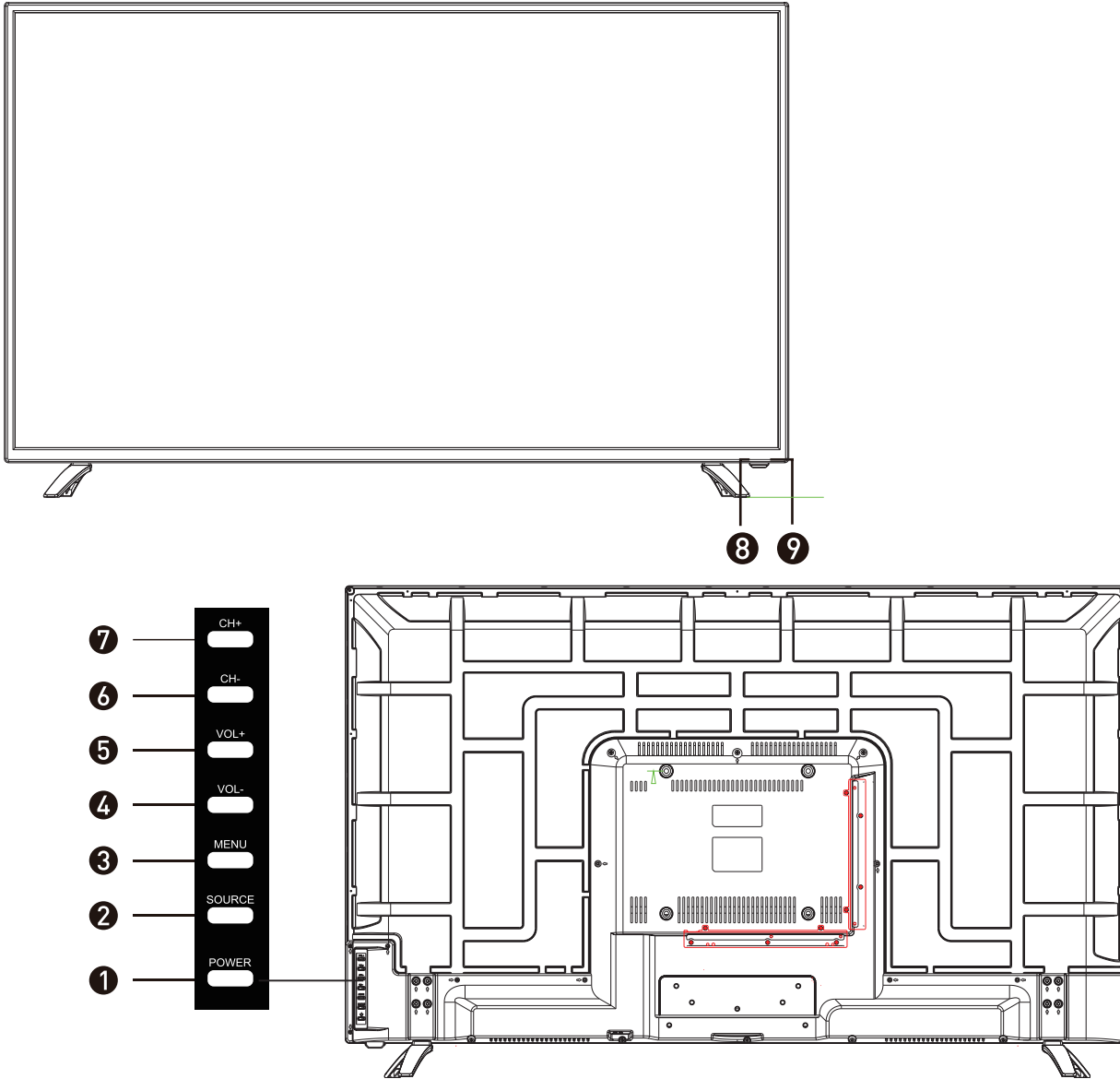

1. POWER: Turn on TV/Standby
2. SOURCE: Audio/Video input source selection
3. MENU: Open settings menu
4. VOL-: Decrease volume
5. VOL+: Increase volume
6. CH-: Previous channel
7. CH+: Next channel
8. IR RECEIVER: Receives infrared signals from the remote control
9. INDICATOR LED: Status indicator

Introduction

1.3.2 Connection Panel

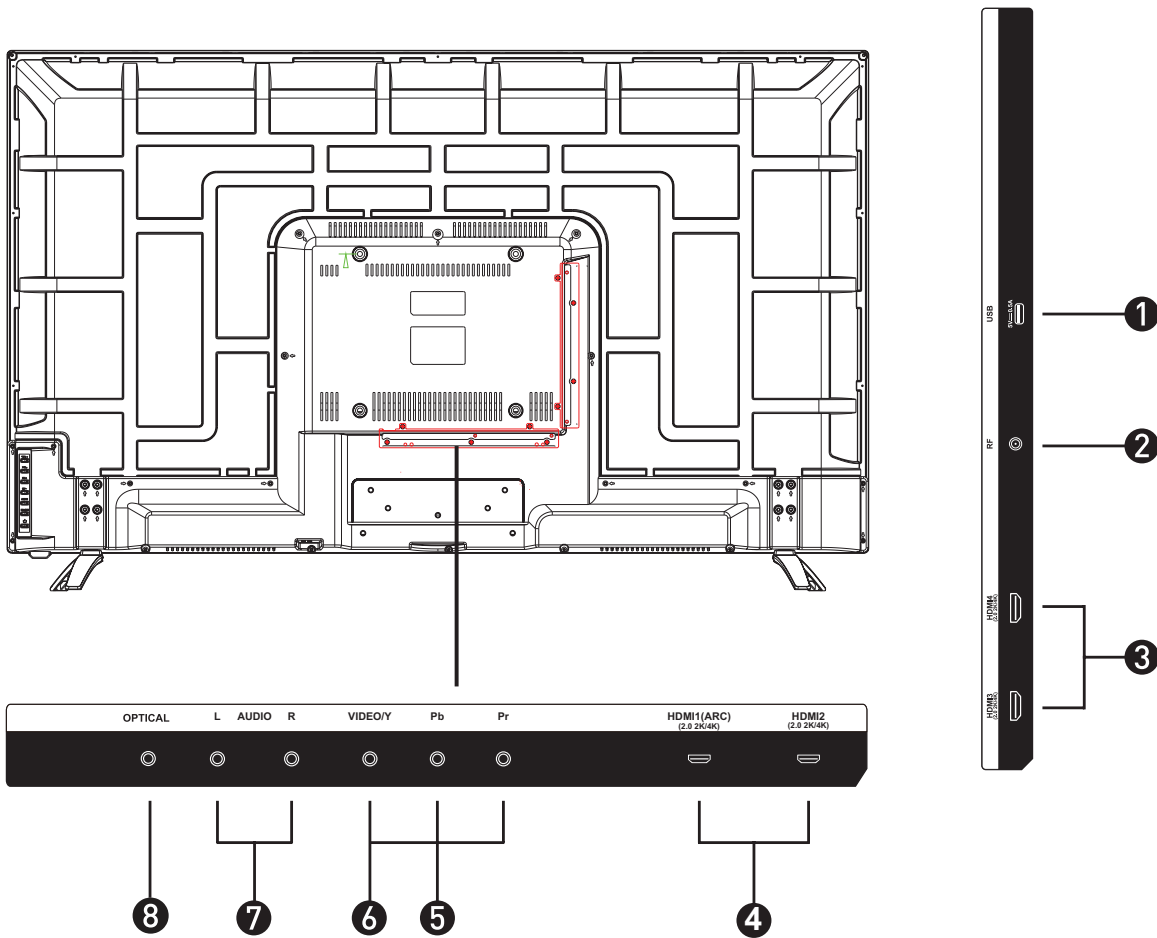

1. USB
2. RF: Antenna connection
- 3-4. HDMI
5. YPbPr: Connect to the YPbPr video output terminal of DVD
6. Video: Video input
7. AUDIO IN R/L: Stereo audio input
8. OPTICAL

Introduction

1.3.3 Remote Control

1. POWER: Turn on TV/Standby
2. SOURCE: Press to change signal source
3. MUTE: Mute or restore the sound
4. NUMBER KEYS: Change the channel directly
5. **10+**: Channel setup/DVD 10+ button
6. SUBTITLE: Select subtitle of media video file. (needs the support of disk or file)
↔: Return to the previous channel tuned
7. INFO: Show information about the current program
8. MENU: Display menu page
9. GOTO: Play from the desired location
10. EPG: Show the Electronic Program Guide
11. EXIT: Exit the Menu
12. TITLE: Go to the title page of DVD disc
13. NAVIGATION KEYS (Up, Down, Left, Right and OK): To move in the menus and confirm settings
14. VOL: Increase and decrease volume
15. CH: Next and Previous channel
16. S.MODE: Setting audio options
17. P.MODE: Output image mode selection
18. AUDIO: Switch the audio channel when DVD or multimedia playing
19. MTS: In the TV condition, press this button to select the stereo mode
20. SLEEP: Auto Power Off Timer
21. REPEAT: Repeat mode
22. FREEZE: Freeze the image
23. CC: CC mode
24. MENU: Display menu page
25. A-B: Press display button to repeat the play in the time of A to B
26. AUTO: Press to adjust the picture automatically in PC mode
27. ASPECT: Selects the screen size
28. CH.LIST: Show the list of channels
▲: Eject disc.
29. DVD.SETUP: Open DVD mode system settings menu
30. FAV: Show the list of favourite channels
▶||: Play/Pause
31. ADD/ERASE: Add/erase the favorite channels
■: Stop playback
32. **▶▶**: Next file or chapter
33. PREV/V-CHIP button
◀◀: Previous file or chapter
34. **◀◀**: Fast rewind playback
35. **▶▶**: Fast forward playback

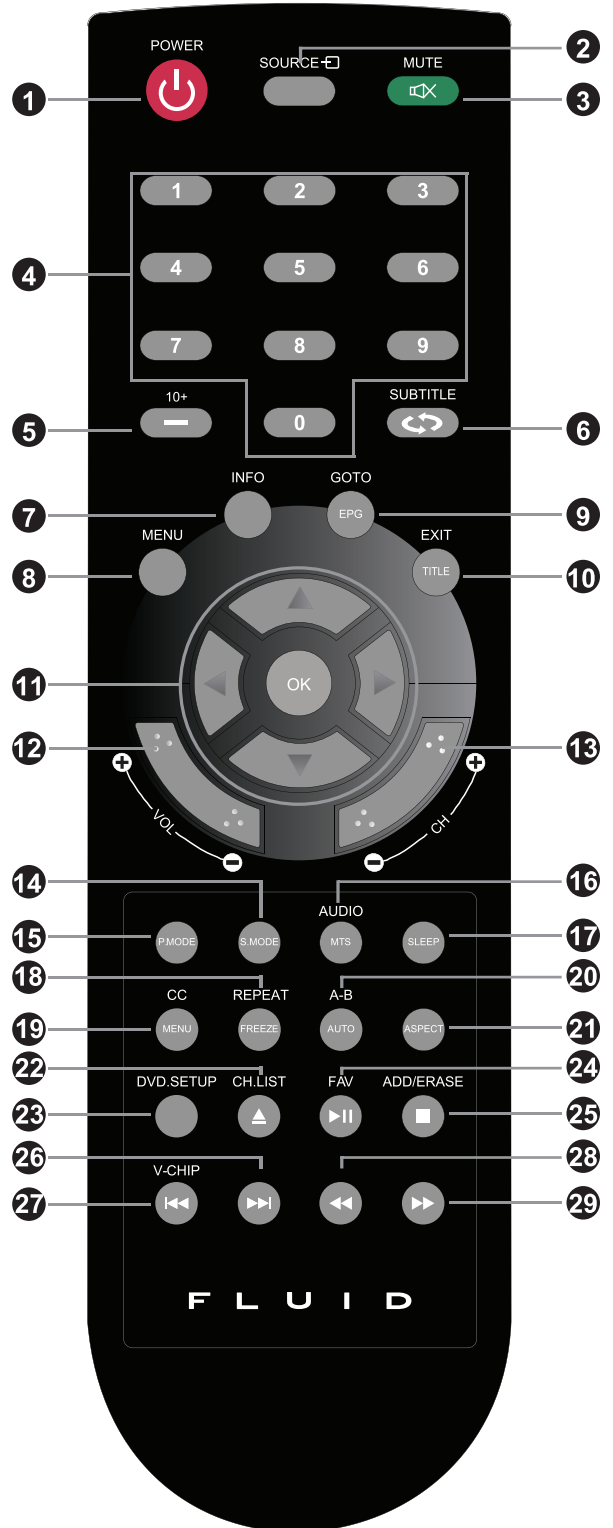

Introduction

Installing the Batteries

If the remote control fails to operate the TV functions, replace the batteries in the remote control.

1. Open the battery cover.
2. Insert two AAA batteries. (Place the batteries with their terminals corresponding to the (+) and (-) indications in the battery compartment.)
3. Replace the cover.

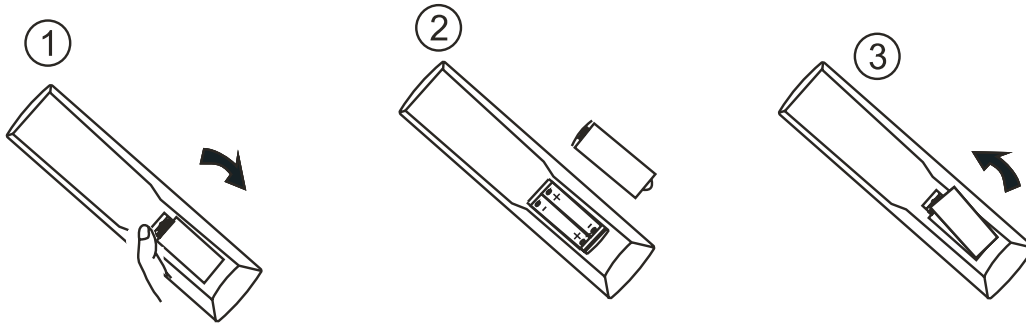

Precaution on Battery Use

Improper use of batteries can result in a leakage of chemicals and/or explosion. Be sure to follow the instructions below:

- Place batteries with their terminals corresponding to the (+) and (-) indications
- Different types of batteries have different characteristics. Do not mix batteries of different types
- Do not mix old and new batteries. Mixing old and new batteries can shorten the life of new batteries and or cause old batteries to leak chemicals
- Remove batteries as soon as they are non-operable. Chemicals that leak from batteries can cause a rash. If chemical leakage is found, wipe with a cloth
- If the remote control is not used for an extended period of time, remove the batteries from the remote control
- The batteries (battery pack of batteries installed) shall not be exposed to excessive heat such as sunshine or fire

Installation

2.1 Power Supply Connection

Connect the power adapter to a home power outlet.

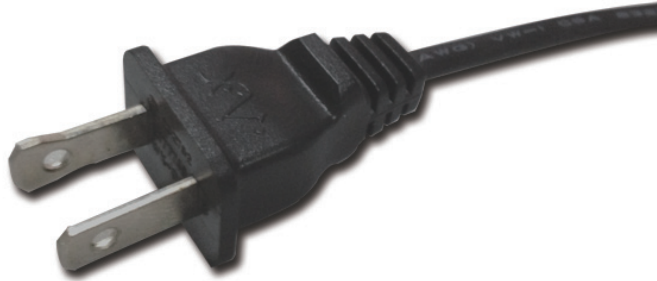

2.2 RF Antenna Connection

Connect the antenna as shown in the figure to receive the analog or digital (DTV) TV signal.

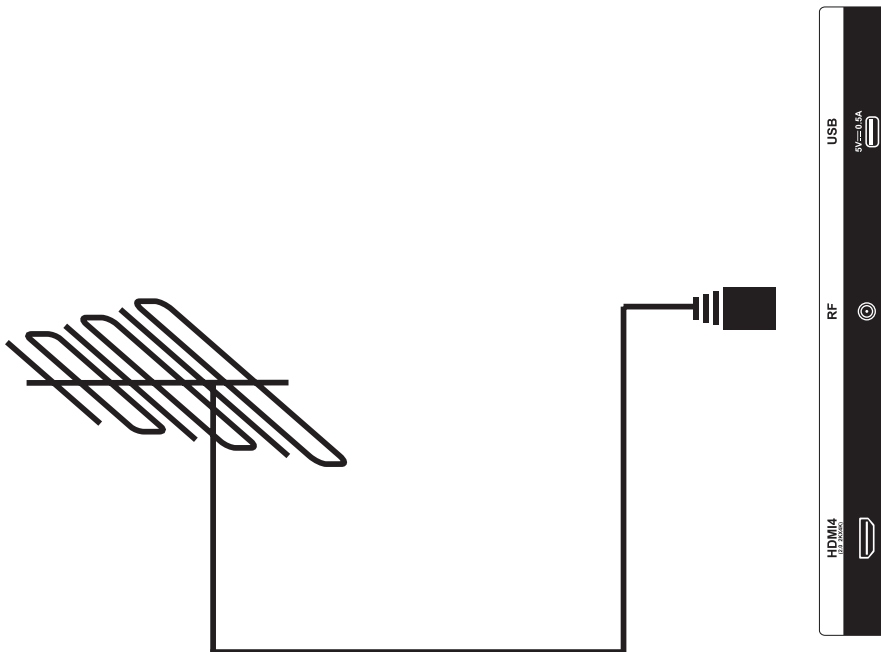

Installation

2.3 Connecting via Composite Video

Connect your video player, decoder, DVD or similar with the corresponding tri-colour RCA cable, from the A/V output (audio/video) of your video equipment to the video and audio input to your TV by the cable, as shown in the figure below.

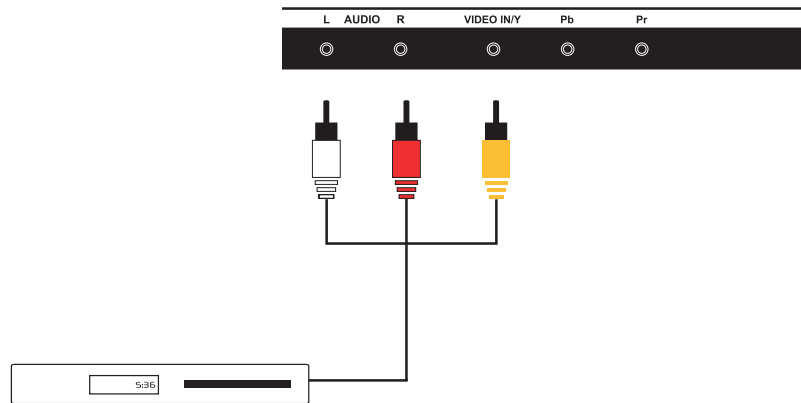

2.4. Connecting via Component Video

Connect your video player, decoder, DVD or similar with an RCA cable, from the YPbPr video output of the device to the video input on your TV by the cable, as shown in the figure below. Through this entry you can get HD video. Use a second RCA cable to connect the audio to AUDIO IN R/L.

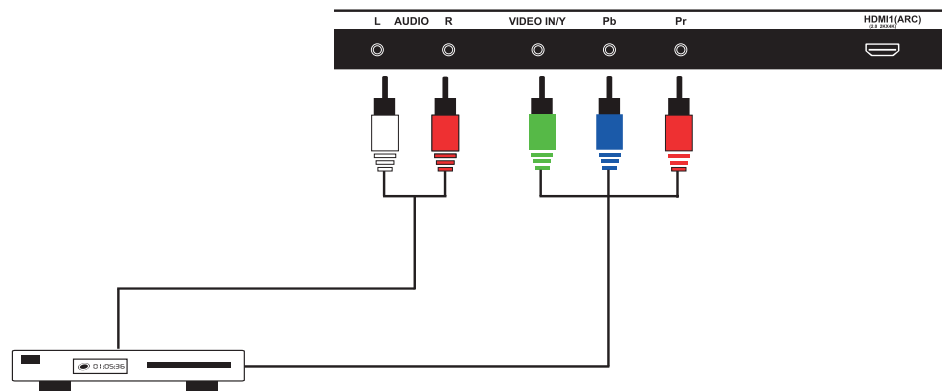

Installation

2.5 Connecting to Digital Audio Amplifier

Take the optical digital audio output of your TV to connect to an existing hi-fi system for an improved sound experience.

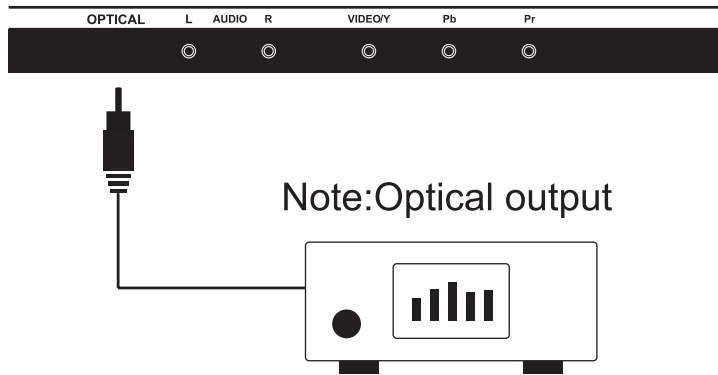

2.6. Connecting via HDMI

Connect your video player, decoder, DVD or similar, with the corresponding HDMI cable from the HDMI output of your video equipment to one of the HDMI input on your TV, as shown in figure. This cable transfers HD video and audio.

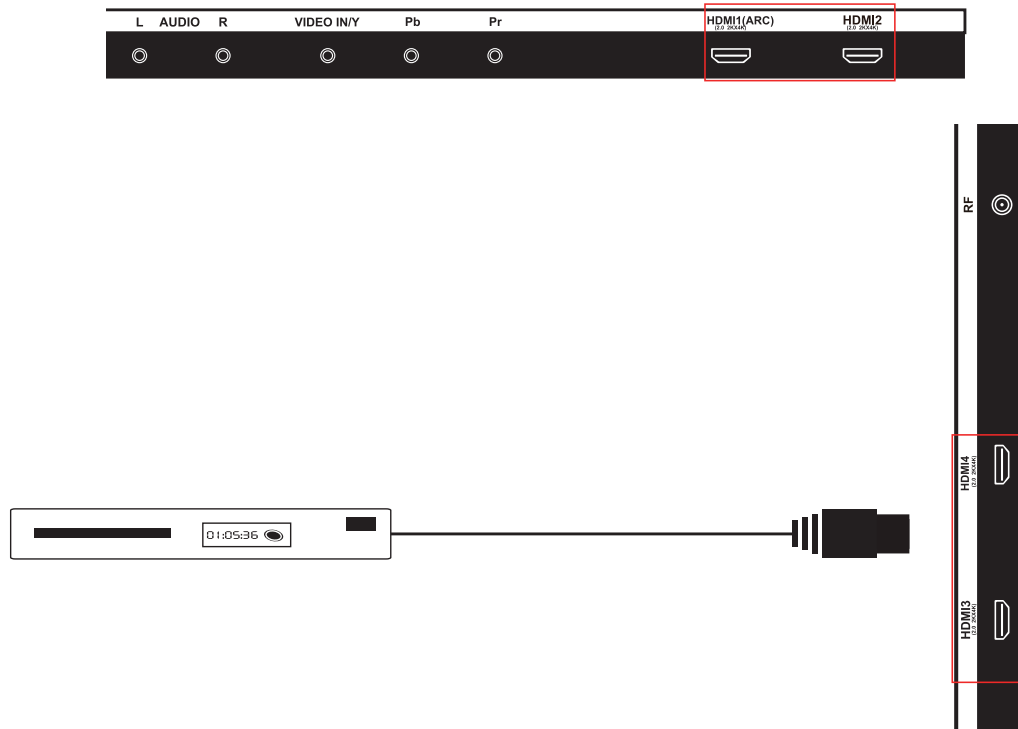

Setup Wizard

Connect an RF cable from the TV's input called "RF-In" and to your TV Aerial socket.

3.1 Select Language

Press ◀/▶ button to select the language to be used for menus and message.

Press ▼/▲ button to select go to next step and press OK/▶ button to go.



3.2 Select Time

Press ▼/▲ button to select the appropriate time zone, daylight saving time and time format you want.

Press ◀/▶ button on the remote control to adjust the above settings.

Press ▼/▲ button on the remote control to select the next step and press OK/▶ button to accept.

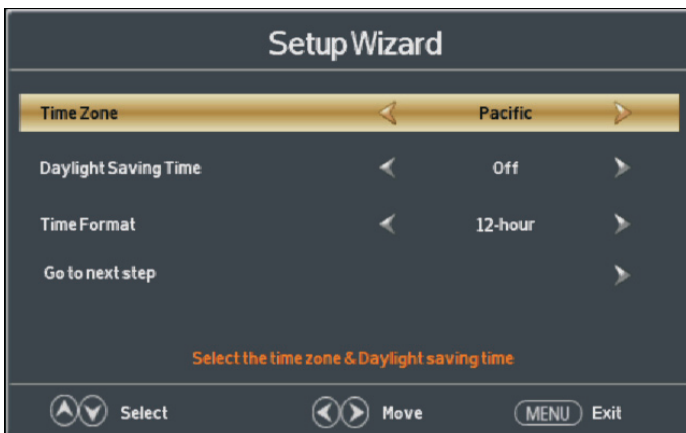

SetupWizard

3.3 Auto Scan

Press ◀/▶ button to select the antenna type.

Press ▼/▲ button to select go to next step and press OK/▶ button to start auto scan.

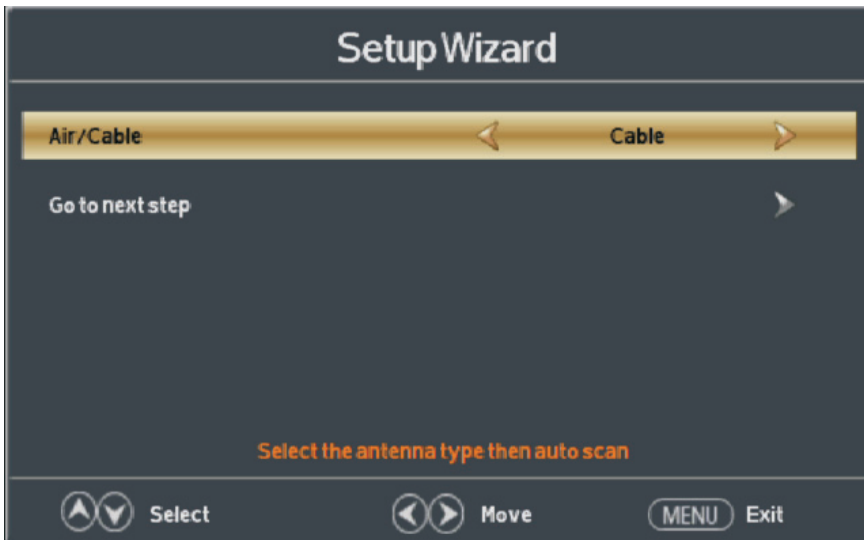

Select Input Source

Press SOURCE button to display the input source list
Press ▼/▲ or SOURCE button to select the input source
Press OK button to enter the input source
Press EXIT button to quit.



4.1 Main Menu



Press MENU to display the main menu, return to the previous menu or close the main menu.
Press to highlight the desired menu icon and press OK to select.
If no buttons are pressed, the menu will close automatically after about 10 seconds.

Main Menu Operation

5.1 Picture Menu

Press MENU to enter the main menu

Press ◀/▶ button to select.

Press OK/▶ to accept.

Press MENU again to exit or back to parent menu.



Press ▼/▲ button to select among Picture Mode/Brightness/Contrast/Colour/Tint/Sharpness/Color Temperature/Advanced Settings.

Press OK/▼ to accept.

Press ◀/▶ button to adjust.

Press MENU again or back to parent menu.

5.1.1 Picture Mode

Adjust picture mode to change picture appearance.

Press ◀/▶ button to select (Standard/Dynamic/Soft/User/Power Saving).

Note: The brightness, contrast, colour, tint and sharpness are only available in User mode, you can adjust as you like.

<i>Standard</i>	<i>Produces a highly defined image in a normally lit room.</i>
<i>Dynamic</i>	<i>Produces a highly defined image in a brightly lit room.</i>
<i>Soft</i>	<i>Produces a highly defined image in a soft lit room.</i>
<i>User</i>	<i>Select to customize picture settings.</i>
<i>Power Saving</i>	<i>Decreases the backlight level.</i>

Main Menu Operation

5.1.2 Brightness

Adjust the visual perception output of the entire picture, it will effect the luminosity of the picture.
Press ◀/▶ button to adjust.

5.1.3 Contrast

Adjust the highlight intensity of the picture, but the shadow of the picture is invariable.
Press ◀/▶ button to adjust.

5.1.4 Colour

Adjust the saturation of the colour based on your own preference.
Press ◀/▶ button to adjust.

5.1.5 Tint

Adjust the hue (Red, Green, Blue) of the picture.
Press ◀/▶ button to adjust.

5.1.6 Sharpness

Adjust the peaking in the detail of the picture.
Press ◀/▶ button to adjust.

5.1.7 Colour Temperature

Increase or reduce warmth or coolness of the picture based on your preference.

5.1.8 Advanced Settings

Adjust advanced video features to fine tune the picture.
Press ▶ button to enter sub-menu.

Main Menu Operation



5.1.9 Aspect Ratio

Adjust how the picture fills the screen.

Normal Automatically adjust Aspect Ratio based on TV size and TV program.

Wide Use to watch wide screen (16:9) content.

Zoom Expands image to fill screen. Top and bottom maybe cut off.

Cinema Stretches image at edges but keeps a clear image in the centre.

5.1.10 Noise Reduction

Set options to reduce video noise.

Off Select to turn off video noise detection.

Low Detect and reduce low video noise.

Medium Detect and reduce moderate video noise.

High Detect and reduce enhanced video noise.

5.1.11 Dynamic Contrast

Automatically adjust picture detail and brightness.

Press ◀/▶ button to select (Off/On).

5.1.12 HDMI Mode

Only available in HDMI input.

Press ◀/▶ button to select (Video/Graphic).

Main Menu Operation

5.2 Sound Menu

Press MENU to enter the main menu, Press ◀/▶ button to select.

Press OK/▼ to enter.

Press MENU again to exit or back to parent menu.



Press ▼/▲ button to select among Sound Mode/Bass/Treble/Balance/MTS/Audio Language/Digital Audio Output/Surround Sound/AVL

Press OK/▼ to enter.

Press ◀/▶ button to adjust.

Press MENU again or back to parent menu.

5.2.1 Sound Mode

Select a sound mode to achieve ideal sound.

Press ◀/▶ button to select (Standard/Music/Movie/User).

Note: The bass, treble and balance are only available in User mode, you can adjust as you like.

- | | |
|-----------------|---|
| <i>Standard</i> | <i>Produces a balanced sound in all environments.</i> |
| <i>Music</i> | <i>Preserves the original sound. Good for musical programs.</i> |
| <i>Movie</i> | <i>Enhances treble and bass for a rich sound experience.</i> |
| <i>User</i> | <i>Select to customize audio settings.</i> |

Main Menu Operation

5.2.2 Bass

Adjust the bass effect. Increases or decreases lower-pitched sounds.
Press ◀/▶ button to adjust.

5.2.3 Treble

Adjust the treble effect. Increases or decreases high-pitched sounds.
Press ◀/▶ button to adjust.

5.2.4 Balance

Adjust the balance between left and right speakers to adapt to your listening position.
Press ◀/▶ button to adjust.

5.2.5 MTS

Configures the multi-track sound. It only appears when using the “TV” source.
Press ◀/▶ button to select (Mono/Stereo/SAP).

Mono *Sets the sound to mono.*

Stereo *Sets the sound to stereo when stereo is not available, the sound is automatically switched to mono.*

SAP *Sets the sound to the second audio program.*

5.2.6 Audio Language

Select the language supported by the chosen digital channel. It is available only in TV.
Press ◀/▶ button to select (English/French/Spanish).

5.2.7 Digital Audio Out

Send digital audio to external audio system.
Press ◀/▶ button to select.

PCM *Select to output audio in 2-channel stereo.*

Raw *Original image coded data.*

5.2.8 Surround Sound

Set the Surround Sound control.
Press ◀/▶ button to select (On/Off).

5.2.9 AVL

Set the auto volume control.
Press ◀/▶ button to select (On/Off).

Main Menu Operation

NOTE:

Balance: This item can adjust the speaker's output, it enables you to listen to the best sound at your position.

AVL: This item is used for reducing the difference between channel and program's volume automatically. This function will also reduce the fluctuation of the sound.

5.3 Time Menu

Press MENU to enter the main menu, Press ◀/▶ button to select.

Press OK/▼ to accept.

Press MENU again to exit or back to parent menu.



Press ▼/▲ button to select among Sleep Timer/Time Zone/Daylight Saving Time/Time Format/Auto Clock/Clock.

Press OK/▼ to accept.

Press ◀/▶ button to adjust.

Press MENU again or back to parent menu.

5.3.1 Sleep Timer

Set a timer for the TV to turn off automatically.

Press ◀/▶ button to select (Off/5min/10min/15min/30min/60min/90min/120min/180min/240min).

Main Menu Operation

5.3.2 Time Zone

Select your time zone.

Press ◀/▶ button to select (Eastern/Central/Mountain/Pacific/Alaska/Hawaii/Atlantic).

5.3.3 Daylight Saving Time

Set the daylight saving time for your area.

Press ◀/▶ button to select (On/Off).

5.3.4 Time Format

Select your time format.

Press ◀/▶ button to select (12-hour/24-hour).

5.3.5 Auto Clock

Use to synchronize the display automatically.

Press ◀/▶ button to select (On/Off).

5.4 Setup Menu

Press MENU to enter the main menu

Press ◀/▶ button to select.

Press OK/▼ to enter.

Press MENU again to exit or back to parent menu.



Press ▼/▲ button to select among Menu Language/Transparent/OSD Timeout/Closed Caption/Over Scan/ Input Label/Other settings/Restore Default/Setup Wizard.
Press OK/▼ to accept.

Main Menu Operation

Press ◀/▶ button to adjust.
Press MENU again or back to parent menu.

5.4.1 Menu Language

Select an OSD menu language can be displayed. Default English is selected as menu language.

Press ◀/▶ button to select language (English/Français/Español).

5.4.2 Transparent

Adjust the transparency of the OSD (on screen display) menu.

Press ◀/▶ button to select. (0%, 25%, 50%, 75%, 100%)

5.4.3 OSD Time Out

Adjust the duration of the OSD (on screen display) menu.

Press ◀/▶ button to select. (5 Sec., 15 Sec., 30 Sec., 45 Sec., 60 Sec.)

5.4.4 Closed Caption

Adjust Closed Captioning settings. Only available under TV and A/V source.

Press OK/▼ to enter.

For detail please refer to page 12.

5.5.1 CC Mode

Turn Closed Captioning on/off.

Press ◀/▶ button to select (CC Off/CC On/CC OnMute).

5.5.2 Analog CC

Set Closed Captioning for standard (analog) program.

Press ◀/▶ button to select (Off/CC1/CC2/CC3/CC4/TEXT1/TEXT2/TEXT3/TEXT4).

5.5.3 Digital CC

Set Closed Captioning for digital program.

Press ◀/▶ button to select (Off/Service1/Service2/Service3/Service4/Service5/Service6).

5.5.4 Option

Adjust the digital Closed Captioning setting.

Press ◀/▶ button to enter.

Main Menu Operation

5.5.5 Mode

Set the look of digital Closed Captioning. Automatic uses broadcaster's style.
Press ◀/▶ button to select (Default/Custom).

5.5.6 Font Style

Select from 8 font styles.
Press ◀/▶ button to select (Default/Font 0/Font 1/Font 2/Font 3/Font 4/Font 5/Font 6/Font 7).

5.5.7 Font Size

Adjust the size of the digital Closed Captioning font.
Press button to select (Default/Normal/Large/Small).

5.5.8 Font Edge Style

Adjust the edge of the digital Closed Captioning box.
Press ◀/▶ button to select (Default/None/Raised/Depressed/Uniform/Left Shadow/Right Shadow).

5.5.9 Font Edge Colour

Adjust the colour of the digital Closed Captioning box.
Press ◀/▶ button to select (Default/Black/White/Red/Green/Blue/Yellow/Magenta/Cyan).

5.5.10 FG Colour

Adjust the colour of the digital Closed Captioning font.
Press ◀/▶ button to select (Default/White/Red/Green/Blue/Yellow/Magenta/Cyan).

5.5.11 BG Colour

Adjust the digital Closed Captioning background colour.
Press ◀/▶ button to select (Default/Black/Red/Green/Blue/Yellow/Magenta/Cyan).

5.5.12 FG Opacity

Adjust the transparency of the digital Closed Captioning font.
Press ◀/▶ button to select (Default/Solid/Flashing/Translucent/Transparent).

5.5.13 BG Opacity

Adjust the digital Closed Captioning background transparency.
Press ◀/▶ button to select (Default/Solid/Flashing/Translucent/Transparent).

NOTE: All the options can not be adjusted while the mode is Default.

Main Menu Operation

Over Scan

Press ◀/▶ button to select (On/Off).

Input Labels

Create labels for the devices connected to your TV.

Press OK/▼ to enter.



Other Settings

Set the parameter of audio only, no operation power off and HDMI 4K.

Press OK/▼ to enter.



Main Menu Operation

Audio Only

Play the audio with the picture turned off. When you turn the Audio Only on and exit the OSD menu, the panel will be dark; and then press any key to exit the Audio Only status.
Press ◀/▶ button to select (On/Off).

5.5.14 No Operation Power Off

To set the TV set power off automatically when there is no operation.
Press ◀/▶ button to select (2 hours/Off).

5.5.15 HDMI 4K

There are two options, the Standard Mode support HDMI 1.4, the Enhancement Mode support HDMI 2.0.
(This model supports HDCP 2.2 Key)

5.5.16 Restore Default

Change power on options or reset TV to factory default.
Press ◀/▶ button to enter.

5.5.17 Setup Wizard

Set the first time installation.
Press OK /▶ button to enter. For detail please refer to page 15-16.

Main Menu Operation

CEC

Press OK/▶ button to accept.



Press ▼/▲ button to select the items you want to adjust and press ◀/▶ to select or enter the sub-menu.



CEC Control

Set CEC control on/off.

Press ▼/▲ button to select CEC control, and press ◀/▶ to set to on/off.

Main Menu Operation

5.5.19 Device Auto Power Off

Set the device power off automatically.

Press ▼/▲ button to select Device Auto Power Off, and press ◀/▶ to set to on/off.

TV Auto Power On

Set the TV set power on automatically.

Press ▼/▲ button to select TV Auto Power On, and press ◀/▶ to set to on/off.

Audio Receiver

Set the audio receiver on/off.

Press ▼/▲ button to select Audio Receiver, and press ◀/▶ to set to on/off.

Device List

View the CEC device list.

Press ▼/▲ button to select Device list, and press OK/▶ button to accept.

Connect

Connect the selected CEC device.

Press ▼/▲ button to select Connect, and press OK/▶ button to accept.

Root Menu

View the root menu of CEC device

Press ▼/▲ button to select Root Menu, and press OK/▶ button to accept.

5.6 Lock Menu

Press MENU to enter the main menu, press ◀/▶ button to select.

Press OK/▼ to accept.

Press MENU again to exit or back to parent menu.



Main Menu Operation

Press ▼/▲ button to select among Change Password/System Lock/Input Block/US Rating/Canada Rating/RRT Setting/Reset RRT.

Press OK/▼ to accept.

Press ◀/▶ button to adjust.

Press MENU again or back to parent menu.



Change Password

Enter a new 4-digital password then re-enter it to confirm.
Press ▶ button to accept.

System Lock

Lock or unlock the buttons on the TV
Press ◀/▶ button to select (Off/On).

5.6.1 Input Block

Block or unblock the input sources.
Press ▶ button to accept. Press ◀/▶ button to select (Unblock/Block).



Main Menu Operation

5.6.2 US Rating

Restrict movie and TV programs by US Ratings.
Only available when "System Lock" is "ON".
Press ► button to accept. For detail please refer to page 16-17.

Canada Rating

Restrict movie and TV programs by Canadian Ratings.
Only available when "System Lock" is "ON".
Press ► button to accept. For detail please refer to page 17.

RRT Setting

Display in advance V-Chip rating table for digital channels.
The item is available only when current stream has downloadable rating data.

Reset RRT

Reset the RRT to default.
The item is available only when current stream has downloadable rating data.

5.7 US Rating

For the United States, the rating setting basically include the following options:
TV, MPA.

5.7.1 TV

The TV rating includes two aspects: age-based and content-based.



Main Menu Operation

Age	Definition
TV-Y	General Audience
TV-Y7	Parental guidance suggested
TV-G	Parents strongly cautioned
TV-PG	Restricted
TV-14	No one 17 and under admitted
TV-MA	Adult audience only

***NOTE:** The content ratings will increase depending on the level of the age-based rating. For example, a program with a TV-PG V (violence) rating may contain moderate violence, while a TV-14 V (violence) rating may contain intense violence. So locking a higher level option will automatically cause locking the options that have more sensitive level.

5.7.2 MPAA

This system defines the rating control which come from MPAA rules.

Rating	Definition
G	General audience. All ages admitted.
PG	Parental guidance suggested. Some material may not be suitable for children.
PG-13	Parents strongly cautioned. Some material may be inappropriate for children under 13.
R	Restricted. Children under 17 require accompanying parent or adult guardian.
NC-17	No one 17 and under admitted.
X	Adult audience only.
Off	

5.7.3 Canada Rating

For Canada, the rating setting include the following options:
Canada English, Canada French

Canada English: These ratings are for programs which are using English rating system.
Canada French: The ratings are for programs which are using French rating system.

Main Menu Operation

Canada English

Rating	Definition
C	Children
Off	News and sports
C8+	Children 8 years and older
G	General programming
PG	Parental guidance
14+	Viewers 14 and older
18+	Adult programming

Canada French

Rating	Definition
G	General
Off	News and sports
8 ans +	Not recommended for children under age 8
13 ans +	Not recommended for children under age 13
16 ans +	Not recommended for children under age 16
18 ans +	This program is restricted to adults

5.8 Channel Menu

Press MENU to enter the main menu, Press ◀/▶ button to select.

Press OK/▼ to accept.

Press MENU again to exit or back to parent menu.



Press ▼/▲ button to select among Air/Cable/Auto Scan/Favourite/Show/Hide/Channel Number/Channel Label .

Press OK/▼ to accept.

Press ◀/▶ button to adjust.

Press MENU again or back to parent menu.

Main Menu Operation

Air/Cable

Select signal type.
Press ◀/▶ button to select (Air/Cable).

5.8.1 Auto Scan

Automatically search for channels. Press OK/▼ to accept.

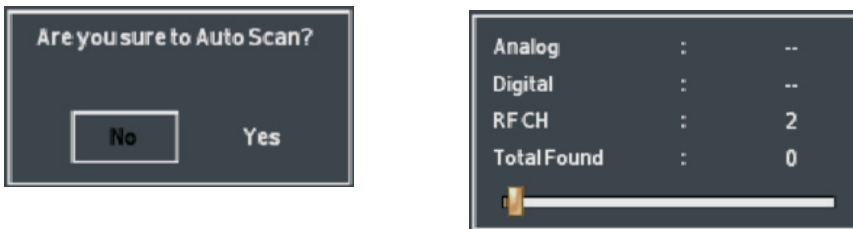

Favourites

Add channels to create a favorite list. Press ▶ button to accept.

Channel List

Display your program list. Press ▶ button to accept.

5.8.2 Show/Hide

Show or hide the channels in your program list. Press ▶ button to accept.

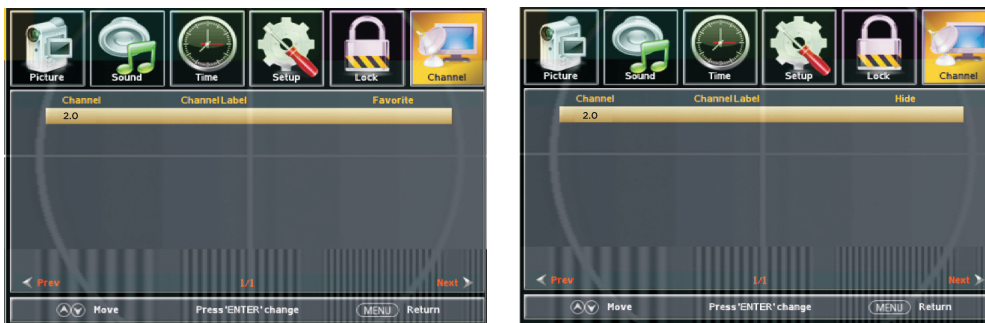

Channel Number

Show the channel number. Press ◀/▶ button to adjust.

Main Menu Operation

5.8.3 Channel Label

Create labels for channels, up to 7 characters. Press ◀/▶ button to adjust.



AV/COMPONENT DVD/HDMI

1. PICTURE menu and description are the same as that for TV mode.
2. MTS and Audio Language in SOUND menu is invalid.
3. TIME menu and description are the same as that for TV mode.
4. Close Caption in SETUP menu is invalid for COMPONENT/DVD/HDMI mode.
5. US Rating, Canada Rating, RRT Setting and Reset RRT in LOCK menu are invalid for COMPONENT/DVD/HDMI mode.
6. AV/COMPONENT/DVD/HDMI mode has no CHANNEL menu.

6. Media

6.1 Media Operation

Note: Before operating Media menu, plug in USB device, then press SOURCE button to set the Input Source to USB.

Press ◀/▶ button to select Media in the Source menu, then press the OK button to accept.

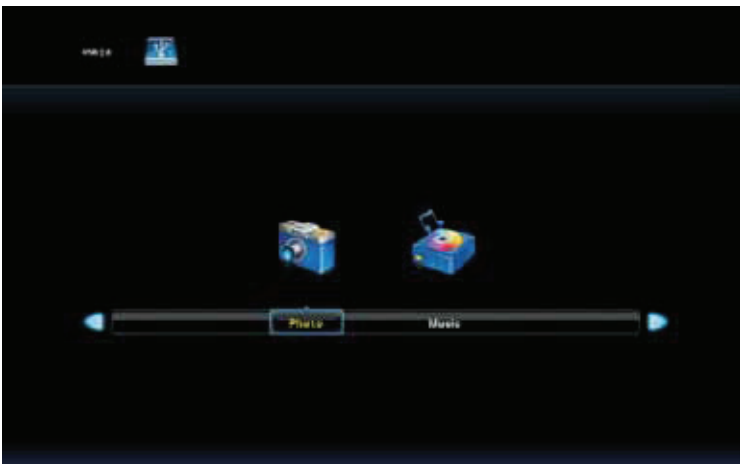

Press ◀/▶ button to select the option you want to adjust in the main Media menu, then press the OK button to accept.

Media



6.2 Photo Menu

Press ◀/▶ button to select PHOTO in the main menu, then press OK button to accept.

Press EXIT button to return back to the previous menu and exit menu to quit.

Press ◀/▶ button to select drive disk you want to watch, then press OK button to accept.

Press ◀/▶ button to select return option to back to the previous menu.

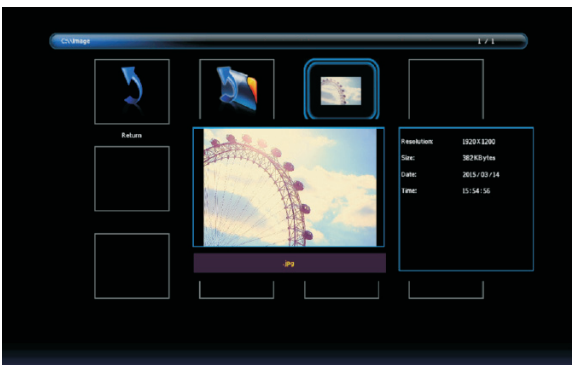

Press ◀/▶ button to select the file you want to watch in the file selecting menu, then press ▶|| button to display picture.

When highlighting the option you select, the file information will appear on the right and picture will be previewed in the centre.

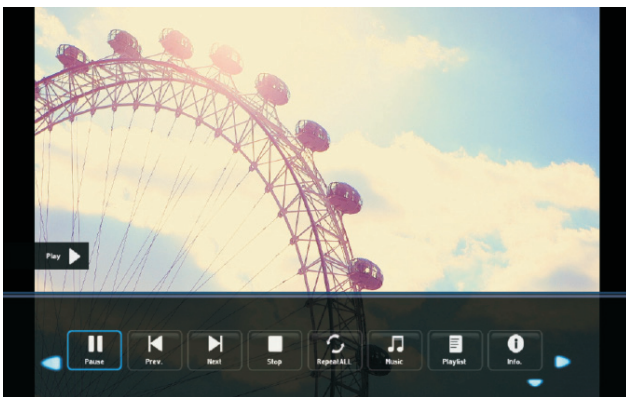

Press ◀/▶ button to select the file folder you want to search in the file selecting menu.

Media

6.3 Music Menu

Press ◀/▶ button to select MUSIC in the main menu, then press OK button to accept.
Press menu button to return back to the previous menu and exit menu to quit.

Press ◀/▶ button to select drive disk you want to watch, then press OK button to accept.
Press ◀/▶ button to select return option to go back to the previous menu.

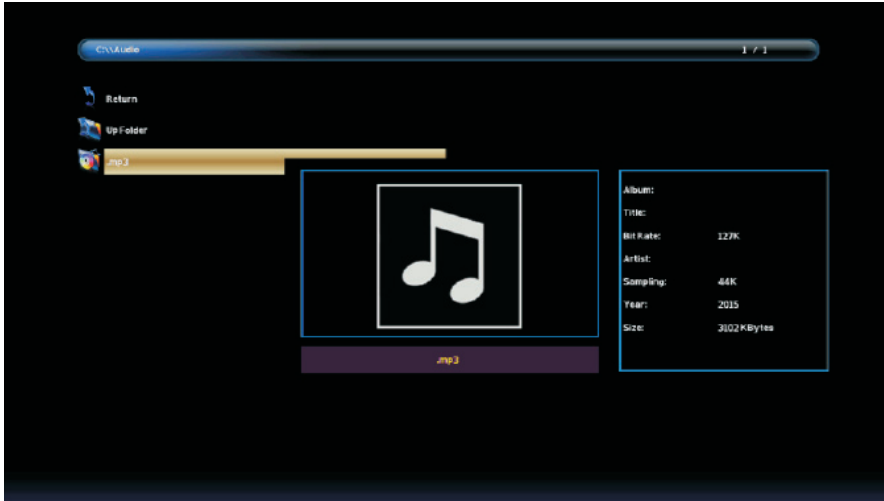

Press ◀/▶ button to select the file you want to watch in the file selecting menu, then press OK button to add the file to play list, press ▶|| button to display and operate file details.
When highlighting the option you select, the file information will appear on the right.

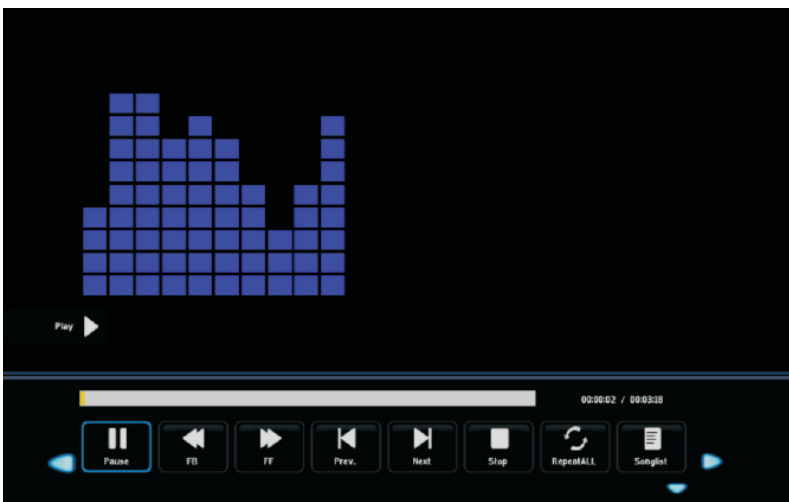



Press ◀/▶ button to select menu in the bottom you want to run, then press OK button to accept.
Press Menu button to back to the previous menu and exit button to quit the entire menu.
Press ▼ button to hide the menu at the bottom.

Troubleshooting

7. Troubleshooting

If the device performance fails, check whether the detected problem is in the following table. If your device still fails, contact the customer service

If TV has no display and red LED is flashing	<ul style="list-style-type: none"> - Signal cable is loose or has fallen off 	<ul style="list-style-type: none"> - Check whether the signal cable is loose or has fallen off, and reconnect it if it has disconnected
Remote control distance is short and has poor reception	<ul style="list-style-type: none"> - Emitter of remote control was covered by objects - Remote control's battery is low 	<ul style="list-style-type: none"> - Remove objects obstructing the receiver window of remote control - Change battery
TV display is faint	<ul style="list-style-type: none"> - Adjustment is incorrect - Display mode is incorrect 	<ul style="list-style-type: none"> - Use auto-adjustment function - Use recommended mode
TV display image does not fill the screen	<ul style="list-style-type: none"> - Adjustment is incorrect - Display mode is incorrect 	<ul style="list-style-type: none"> - Use auto-adjustment function - Enter PICTURE to adjust horizontal or vertical position - Use recommended mode
Will not turn on	<ul style="list-style-type: none"> - Exterior influence, for example lightning, static electricity and so on, which are possibly disrupting the normal operation of this machine 	<ul style="list-style-type: none"> - Press  button to turn off electrical source, then press  button to turn on the TV again after 1-2 minutes
White and black static picture and noise	<ul style="list-style-type: none"> - Antenna cable connector is loose or cable is damaged - Antenna cable type is not matching - Direction or position of antenna is incorrect - Signal is weak 	<ul style="list-style-type: none"> - Check the antenna cable connector plug for loose or damaged connection - Check antenna cable type [VHF/UHF] - Adjust direction or position of antenna - Attempt to use signal amplifier

Troubleshooting

TV image is better but still makes noise	- Antenna cable connector is loose, cable is damaged	- Check the antenna cable connector plug whether or not loose, check cable condition
No image. No sound.	- Power plug is loose, power cord doesn't connect well	- Check power cord whether or not connect well - Press POWER on panel or remote control - Check if the ⏻ button is on
TV image has stripes	- Signal is exposed to interference, such as car, neon light, hair dryer, etc.	- Don't use interfering electronics around machine, adjust antenna cable direction to reduce interference
TV image has shadows	- TV signal is reflected by valley or building - Direction of antenna is incorrect	- Use high directional antenna - Adjust direction of antenna
TV has no sound	- Volume setting is too low - Sound is muted	- Adjust volume to proper value - Press MUTE to eliminate mute

CAUTION: Don't let your machine display the same picture for a long time; please set up a screen protection procedure. If a high contrast picture remains for a long time, this picture will burn a "leave shadow" in screen. Usually the "leave shadow" will disappear gradually when you turn off the power. However, this trouble can't be repaired and is not covered under the warranty.

Specifications

Model	8069024
TV System	ATSC/NTSC
Maximum	3840x2160
Brightness	280 cd/m2
Static Contrast	1200:1
Response Time	6ms
Consumption	<110W
Power Supply	AC 100-120V - 50/60Hz
Connectivity	Composite Video Input Composite Video Input YPbPr HDMI input x 4 RF Antenna Input Optical output
Data Interface	USB
Supported System Files	FAT32/FAT16/NTFS

Remote Control

Signal Type	Infrared
Control Distance	7 metres
Control Angle	30° (Horizontal)
Power Supply	AAA 1.5V x 2

THE SOURCE - WARRANTY



The Source warrants that this product will be free from defects in materials and workmanship for a period of one (1) year from the date of purchase. Within this period, simply take the product and your proof of purchase to any The Source store or participating dealer and the product will be replaced (where available) without charge. Any product which has been subject to misuse or accidental damage is excluded from this warranty.

This warranty is only applicable to a product purchased through The Source company-owned stores or participating dealers in Canada where the warranty is included with the product. While this warranty does not confer any legal rights other than those set out above, you may have additional statutory rights which will vary under the laws of the various countries, states, provinces and other governmental entities in which The Source operates. This warranty is subject to all statutory rights you may have in Canada.

Imported by:
The Source,
Barrie, Ontario, Canada, L4M 4W5
Manufactured in China
www.thesource.ca

© 2017 The Source
All rights reserved.